

**Appendix For Scale Technicians**

## Calibrating a TS-700 Series Indicator

**NOTICE:** The TS-700 SS/MS/WB are NTEP Class III Legal for Trade approved and certified. Unlocking the calibration parameters is not allowed by persons other than qualified scale technicians.

### **DEFAULT SETTINGS CAUTION**

Placing the indicator in calibration mode enables access to the Default Settings Parameter, C07.

*NEVER activate Parameter C07 unless you are a qualified scale technician,* and:

- A) You understand that all custom settings will be deleted permanently, and
- B) You understand how to restore all custom parameters to the required settings based on the scale's specifications and usage.

### **ALL MODELS: Place the Indicator in Calibration Mode and Determine if the Calibration Parameters are Accessible**

- 1) Power on the indicator.
- 2) Press the PRINT and HOLD keys. "C" will display. Release the keys.
- 3) If the calibration parameters are accessible, "C01" will display, with the 1 flashing. Proceed to page 8, "CALIBRATION PROCEDURE".

**NOTE:** If C08 Displays instead of C01, the calibration switch must be adjusted. Disconnect the AC adapter and power off the indicator.

**Appendix For Scale Technicians**

**Calibration Switch, TS-700 MS:** Remove the screws and the back plate of the enclosure. A white-capped calibration switch is located at the bottom left corner of the circuit board. Press the switch fully in and release. This will place the switch in the up position, allowing access to the calibration parameters. Loosely reattach the rear plate.

**Calibration Switch, TS-700 SS:** Remove the screws and the back plate of the enclosure. A calibration switch is located at the bottom left corner of the circuit board. Move the switch to the “On” position, allowing access to the calibration parameters. Loosely reattach the rear plate.

**Calibration Switch, TS-700 WB:** Disconnect all cables and cords. To remove the back plate of the enclosure, place the indicator upside down (not face down) on a work surface. Locate the two slotted holes near the connection sockets. Insert a flat blade screwdriver into each slot (one at a time), pushing the blade inward while angled towards the back of the indicator. This will release the retaining prong and enable removal of the back plate. Carefully lift the rear plate.

A white-capped calibration switch is located at the bottom left corner of the circuit board. Press the switch fully in and release. This will place the switch in the up position, allowing access to the calibration parameters. Loosely reattach the rear plate.

**Appendix For Scale Technicians**

**ALL MODELS:** After enabling access to calibration parameters, proceed as follows:

**CALIBRATION PROCEDURE**

- 1) Power on the indicator.
- 2) Press the PRINT and HOLD keys. “C” will display. Release the keys.
- 3) “C01” will display, with the 1 flashing. The indicator is now in Parameter Settings mode.

**Navigating in Settings Mode**

When the indicator is in settings mode, refer to the graphic printed below the key to determine the keypad key’s function.

The ▲ and ▼ arrow keys are used to increase/decrease the value of the flashing digit, or to navigate up and down a list of preset options.

The ◀ and ▶ arrow keys are used to move the active digit over to the left or to the right.





The ⏪ key and ⏩ key can be used to move forward or backward through the parameters. Also, the ⏴ key is used to enter/accept changes after they have been made to the parameter settings.

The ⏶ key can be used to exit settings mode.





With the indicator in settings mode and the calibration weight nearby, proceed with the calibration process while referring to the following chart:

**NOTE:** After completing and verifying the calibration, set the calibration switch to the “Off” position and securely fasten the rear plate.



**Appendix For Scale Technicians**

PARAMETER	FUNCTION	OPTIONS
C01	Default weighing unit	1 = kg 2 = lb  Description: With C01 flashing, press the  key, then use the up or down arrow keys to change the parameter setting as needed. Press the  key to accept the setting and continue on to the next parameter.
C02	Decimal location	0 = none 1 = one decimal place 2 = two decimal places 3 = three decimal places  Description: With C02 flashing, press the  key, then use the up or down arrow keys to change the parameter setting as needed. Press the  key to accept the setting and continue on to the next parameter.





**Appendix For Scale Technicians**

PARAMETER	FUNCTION	OPTIONS
C03	Graduations	<p>1 = one unit 2 = two units 5 = five units 10 = ten units 20 = twenty units 50 = fifty units</p> <p>Description: With C03 flashing, press the  key, then use the up or down arrow keys to change the parameter setting as needed. Press the  key to accept the setting and continue on to the next parameter.</p>
C04	Capacity	<p>Description: With C04 flashing, press the  key, then use the left and right arrow keys to select the active digit, then use the up and down keys to adjust the digits to the desired capacity, i.e., 5,000. Press the  key to accept the setting and continue on to the next parameter.</p>

**Appendix For Scale Technicians**

PARAMETER	FUNCTION	OPTIONS
C05	Zero Calibration	<p>0 = skip zero calibration 1 = proceed with zero calibration</p> <p>Description: With C05 flashing, press the  key, then use the up arrow key to change the 0 parameter setting to 1. Press the  key to proceed. The zero cal will count down from 10. Press the  key to proceed to the next parameter.</p>

**Appendix For Scale Technicians**

PARAMETER	FUNCTION	OPTIONS
C06	Calibration	<p>0 = skip calibration 1 = proceed with calibration</p> <p>Description: With C06 flashing, press the  key, then use the up arrow key to change the parameter setting to 1. Press the  key to proceed. "Span" will briefly display, then all digits will display. Load the weighing platform, then adjust the displayed digits to match the weight on the platform, i.e, 4,000. Press the  key to proceed. The indicator will calibrate, then display "CalEnd".</p> <p><b>PRESS THE  KEY TO ACCEPT THE CALIBRATION AND EXIT SETTINGS MODE.</b></p>

**CAUTION -- IMPORTANT NOTICE!!**  
*After calibrating, be sure to exit settings mode without activating parameter C07!*

Parameter C07 is the parameter that can DELETE all custom settings and reset the indicator to factory settings.

**Appendix For Scale Technicians**

PARAMETER	FUNCTION	OPTIONS
<b>C07 CAUTION!!</b>	<b>FACTORY RESET...</b> <b>Erases all custom settings!</b>	0 = skip reset to factory defaults 1 = proceed with reset to defaults  Description: To reset to factory defaults, change the 0 setting to 1 and press the  key.



**Appendix For Scale Technicians**

## Load Cell Connections

The indicator can connect with a maximum of eight (8) 350Ω load cells, 4 wire or 6 wire configurations.

Excitation voltage for the load cell is 5VDC, the maximum output current is 120mA.

### TS-700MS/WB Load Quick-Connect Pins

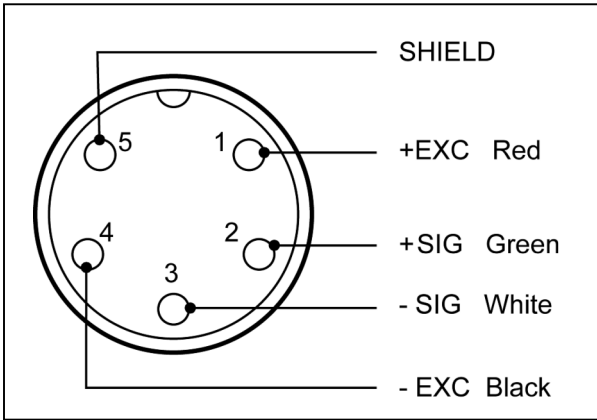

### TS-700 SS Load Cell Terminal Block

